

HANDLEIDING



Container ombouw Yente



BENODIGDHEDEN

Benodigde gereedschappen



Plank 135 x 16 mm

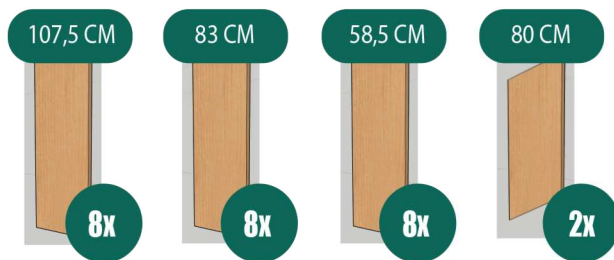

Balk 67 x 44 mm

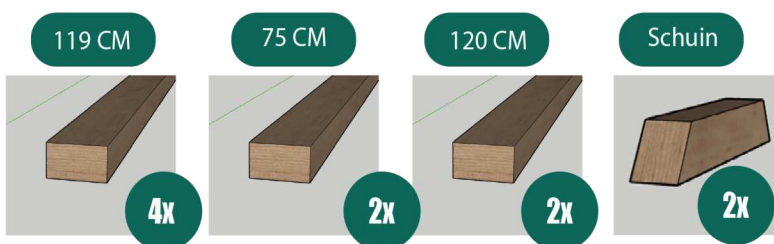

Balk 44 x 44 mm

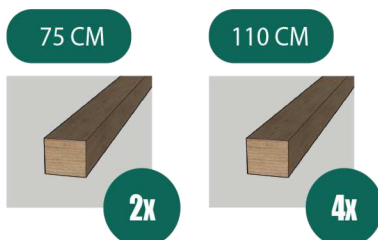

Zweeds zwart rabat



Instructies

Controleer alle onderdelen op deze onderdelen lijst vóór montage. Start niet met monteren bij ontbrekende onderdelen.

Neem de instructies van montage aandachtig door en volg deze stap voor stap voor een goede montage.

Voor optimale bescherming van de materialen adviseren wij het product op een vlakke en verharde ondergrond te plaatsen.

Losse onderdelen

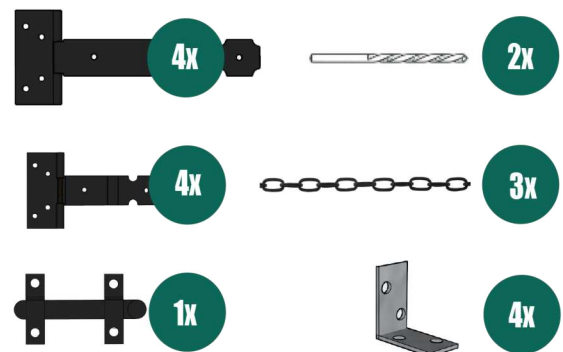

Schroeven & pluggen

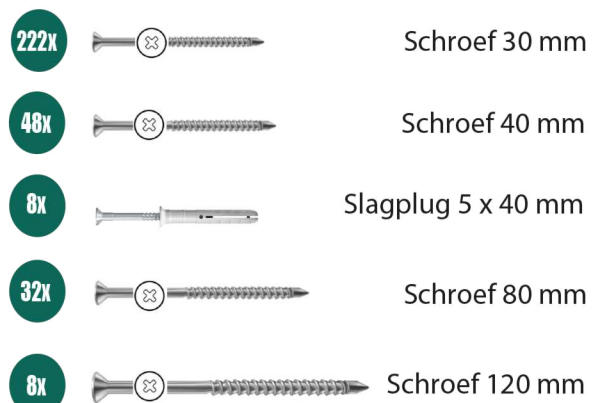

! Let op: Alles voorbereken

MONTAGE STAPPENPLAN

Montage stap 1

- 2x Balk 67x44mm van 119 cm
- 1x Balk 44x44mm van 75 cm
- 4x Schroef 80 mm

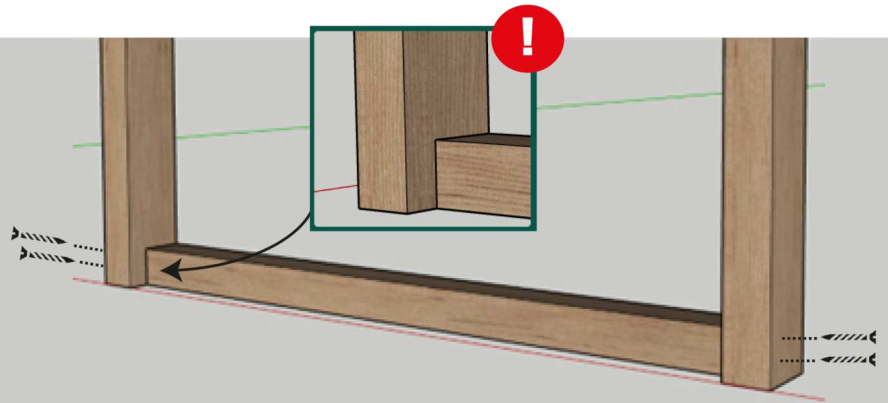

Montage stap 2

- 1x Balk 67x44mm van 75cm
- 4x Schroef 80mm

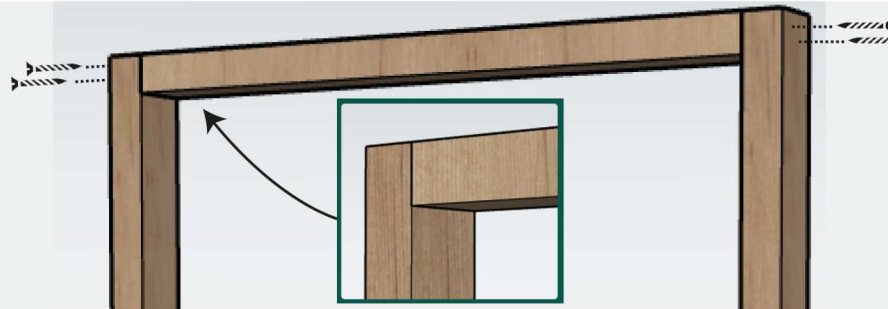

Montage stap 3

- 2x Balk 44x44mm van 110
- 6x Schroef 80mm

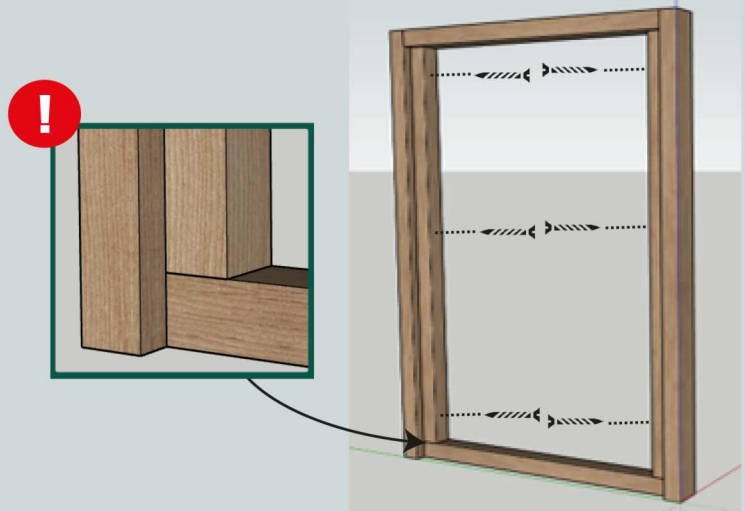

Montage stap 4

- 1x Zweeds rabat plank van 74,8 cm
- 4x Schroef 40mm

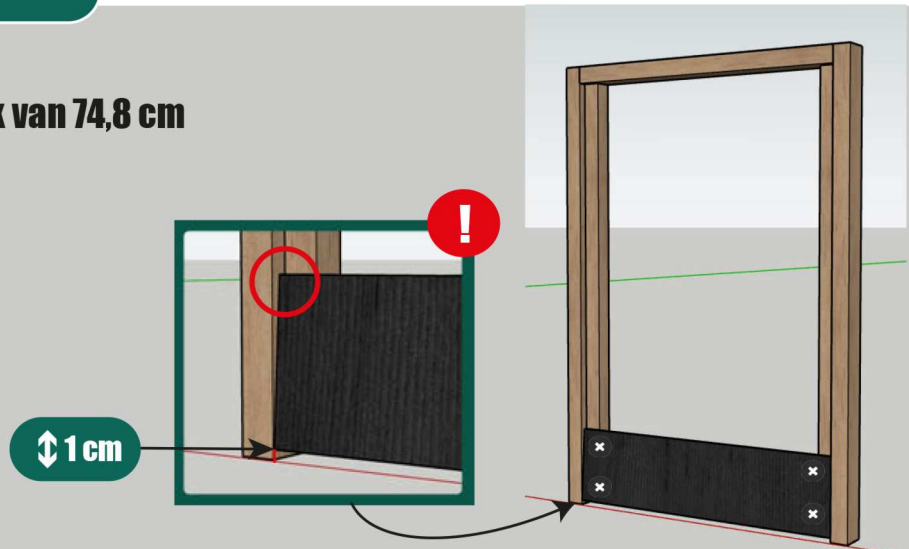

MONTAGE STAPPENPLAN

Montage stap 5

- 5x Zweeds rabat plank van 74,8 cm
- 20x Schroef 40mm

! Verdeel de planken over de volledige hoogte

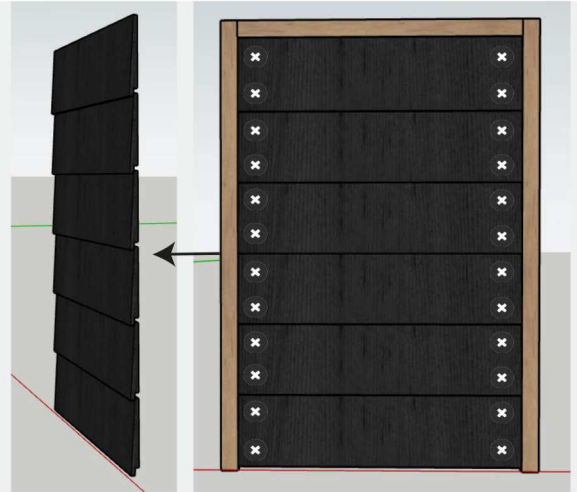

Montage stap 6

Herhaal stap 1 t/m 5 om tot 2 identieke panelen te komen

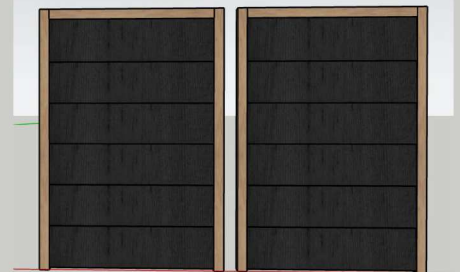

Montage stap 7

- 1x Balk 67x44mm van 120 cm
- 4x Schroef 120mm

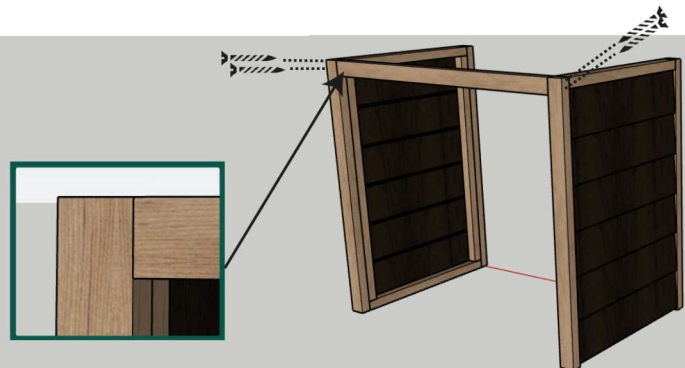

Montage stap 8

- 1x Balk 67x44mm van 120 cm
- 4x Schroef 120mm

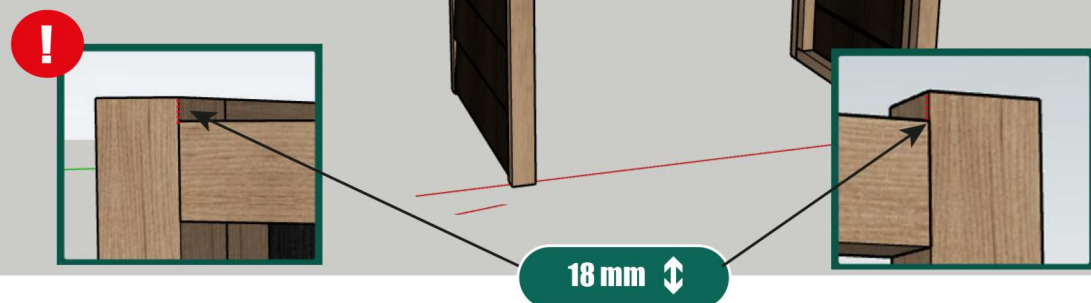

MONTAGE STAPPENPLAN

Montage stap 9

- 4x **Stoelhoek**
- 8x **Slagplug 40mm**
- 8x **Schroef 30mm**

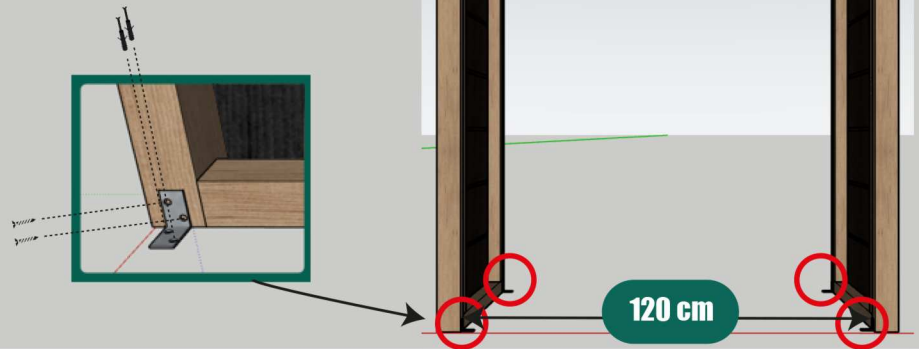

Montage stap 10

- 8x **Plank 135x16mm van 83cm**
- 4x **Plank 135x16mm van 58,5cm**
- 64x **Schroef 30mm**

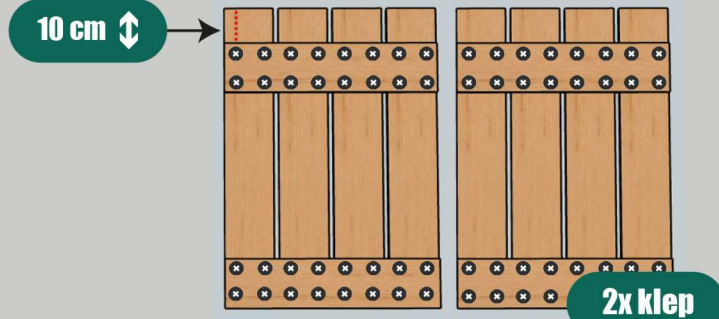

Montage stap 11

- 8x **Plank 135x18mm van 107,5cm**
- 4x **Plank 135x18mm van 58,5cm**
- 2x **Plank 135x18mm van 80cm (schuin)**
- 92x **Schroef 30mm**

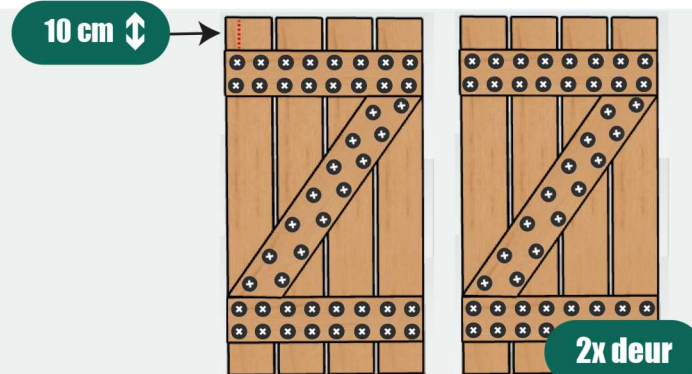

Montage stap 12

- 3x **Klep**
- 4x **Scharnier geheng kort**
- 24x **Schroef 30mm**

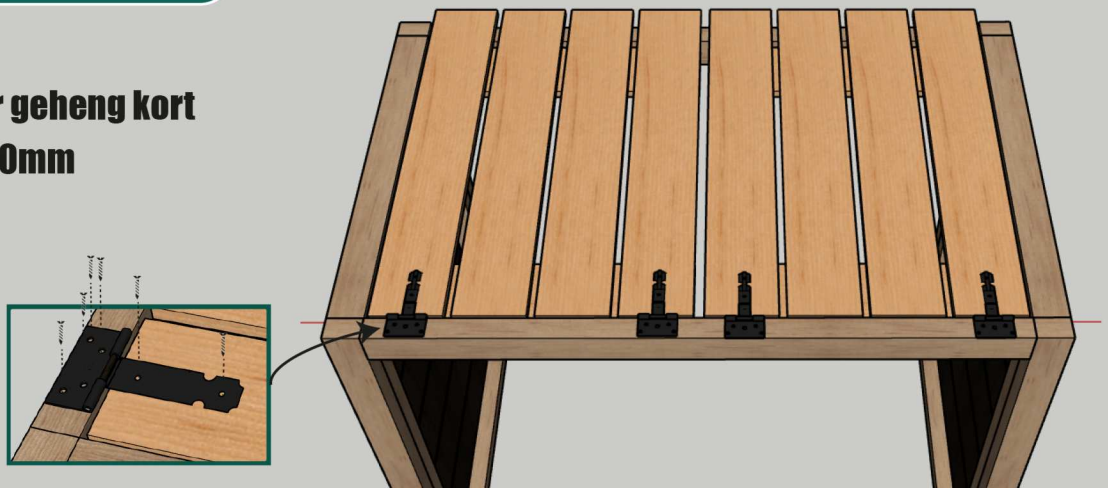

MONTAGE STAPPENPLAN

Montage stap 13

- 2x Deur
- 4x Scharnier geheng lang
- 1x Slot
- 32x Schroef 30mm

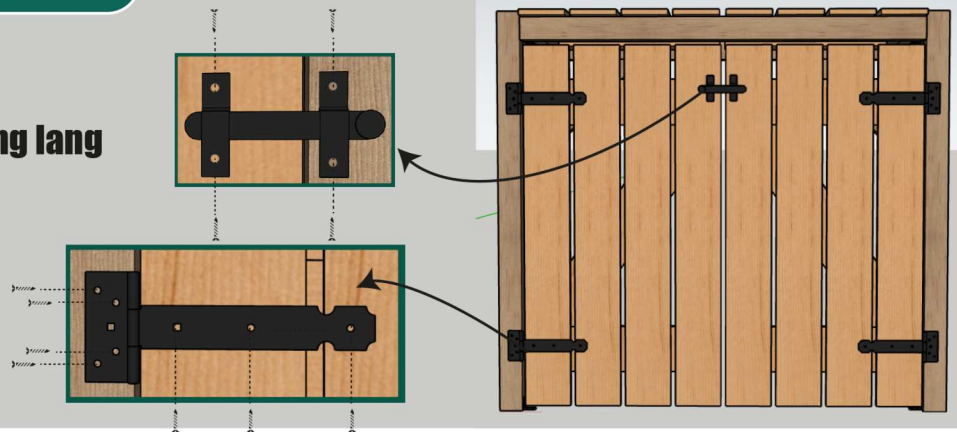

Montage stap 14

- 2x Balk 44x44 (schuin gezaagd)
- 4x Schroef 80 mm

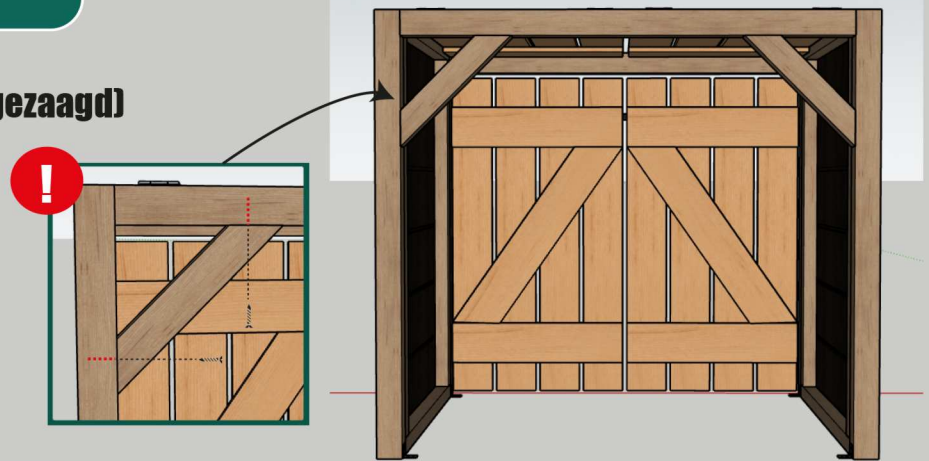

Montage stap 15

- 2x Ketting
- 2x Schroef 30mm

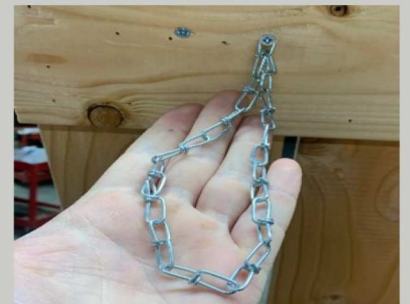
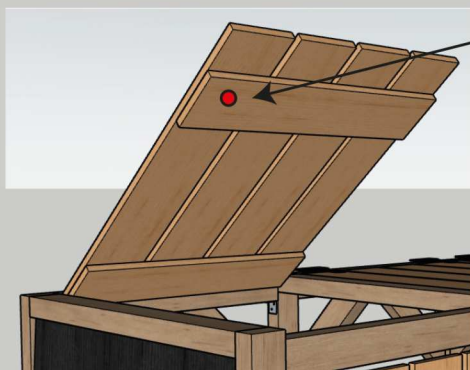

ACHTERWAND MONTAGE STAPPENPLAN

Plank 135 x 16 mm

118 CM



8x

Balk 67 x 44 mm

120 CM

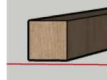

1x

Schroeven & pluggen

32x



Schroef 30 mm

4x



Schroef 100 mm

Montage stap 1

- 1x Balk 67x44mm van 120 cm
- 4x Schroef 100 mm

5 cm

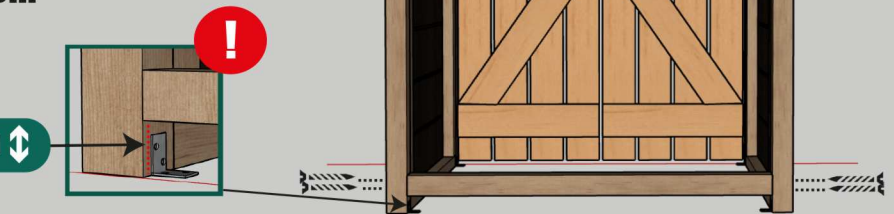

Montage stap 2

- 1x Plank 135x16mm van 118 cm
- 4x Schroef 30mm

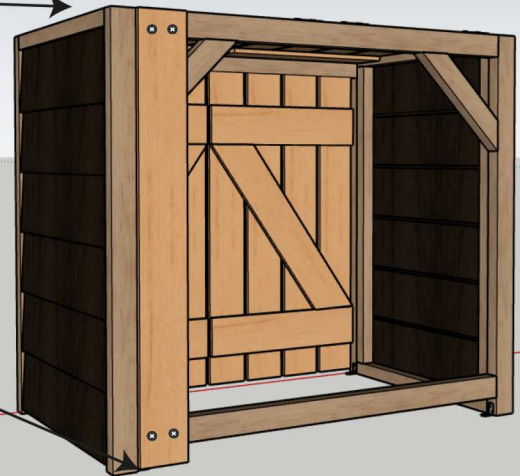

Montage stap 3

- 7x Plank 135x16mm van 118 cm
- 28x Schroef 30mm



Verdeel de planken over de volledige breedte

